

UNIPOR Ziegel Marketing
GmbH
Landsberger Strasse 392
81241 München

UNIPOR
NE-Planziegel

Anlage 1
zur Allgemeinen
bauaufsichtlichen Zulassung
Z-17.1-760
vom 31. März 2006

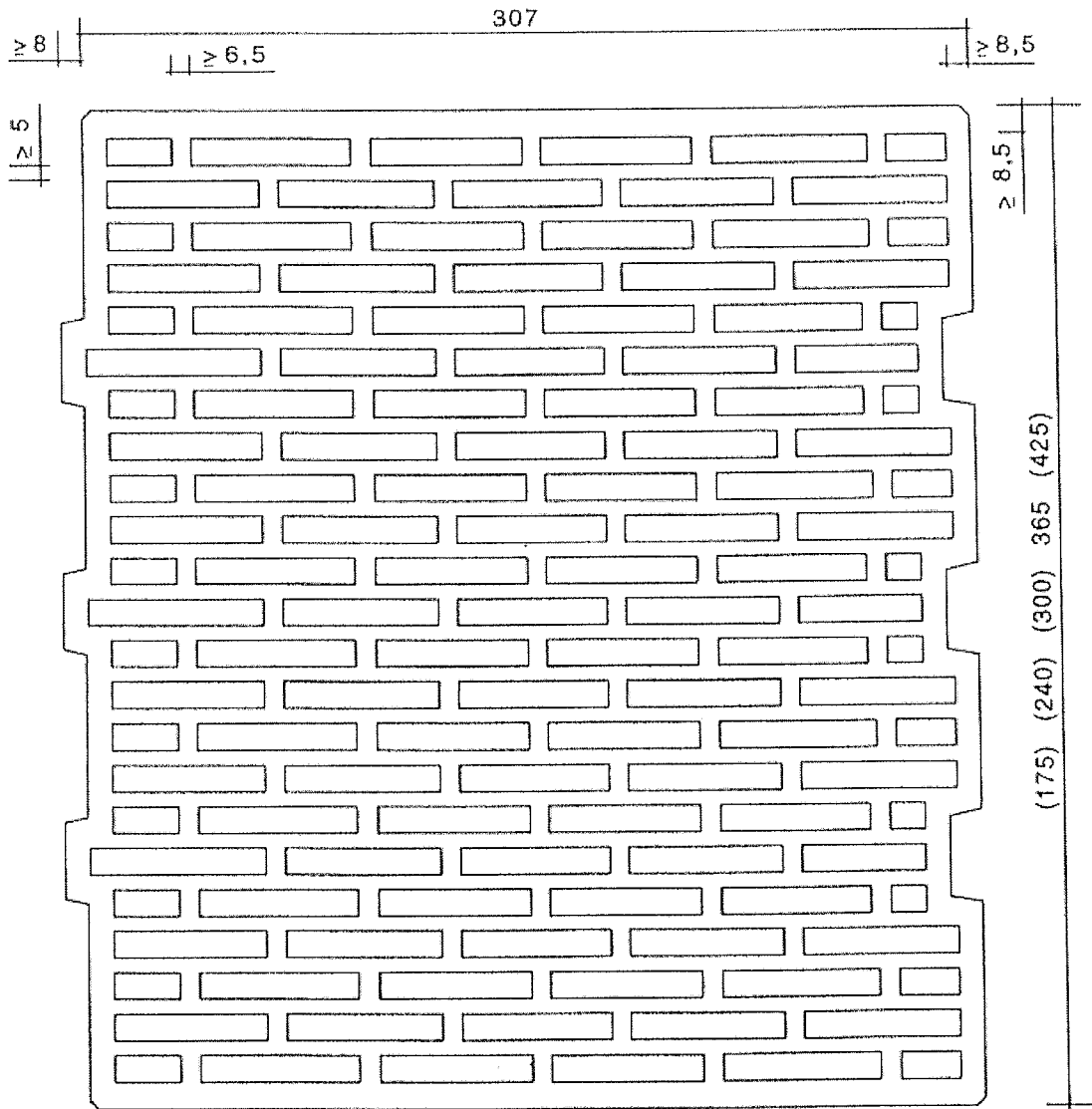

UNIPOR Ziegel Marketing
GmbH
Landsberger Strasse 392
81241 München

UNIPOR
NE-Planziegel

Anlage 2
zur Allgemeinen
bauaufsichtlichen Zulassung
Z-17.1-760
vom 31. März 2006

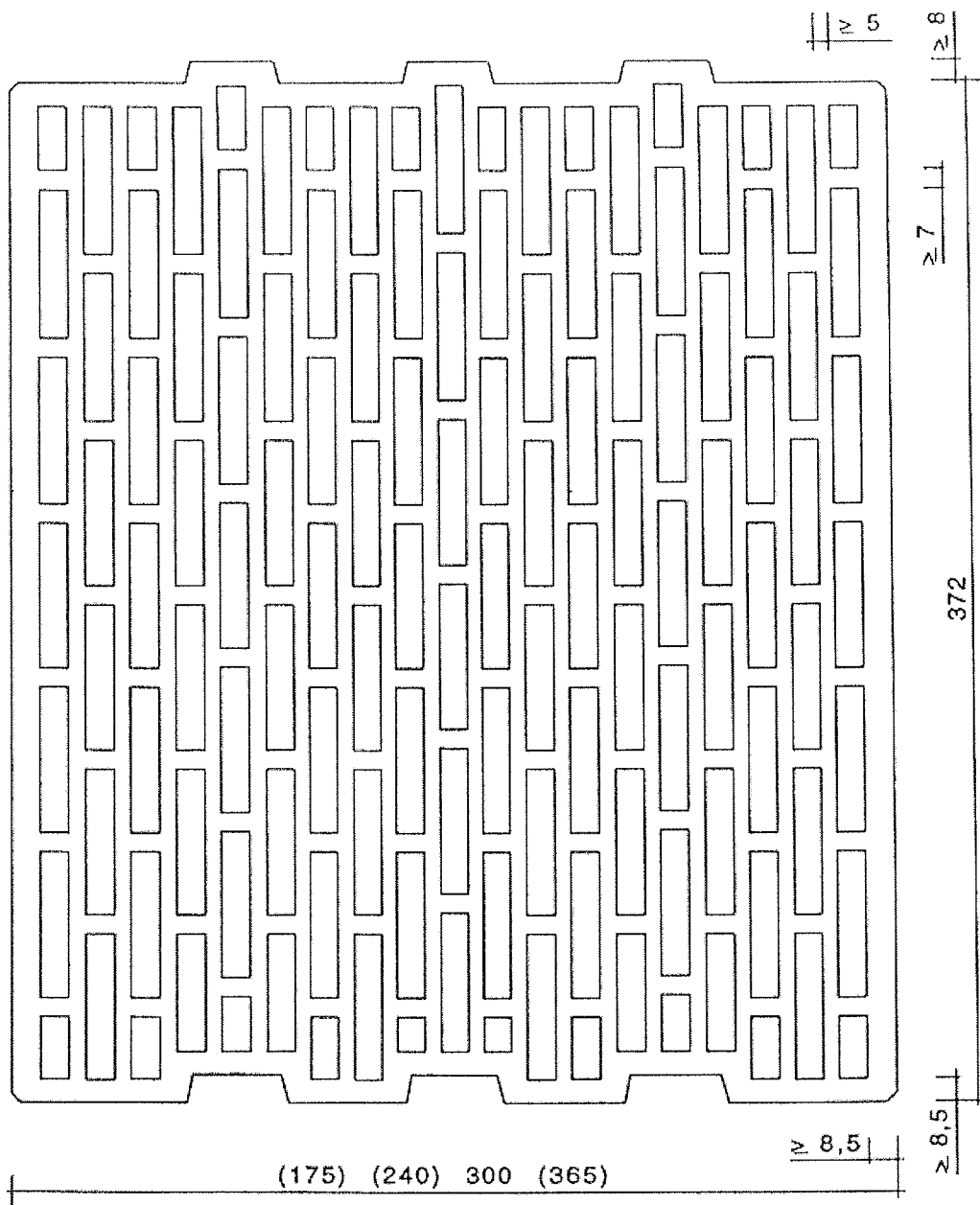

UNIPOR Ziegel Marketing
GmbH
Landsberger Strasse 392
81241 München

UNIPOR
NE-Planziegel

Anlage 3
zur Allgemeinen
bauaufsichtlichen Zulassung
Z-17.1-760
vom 31. März 2006

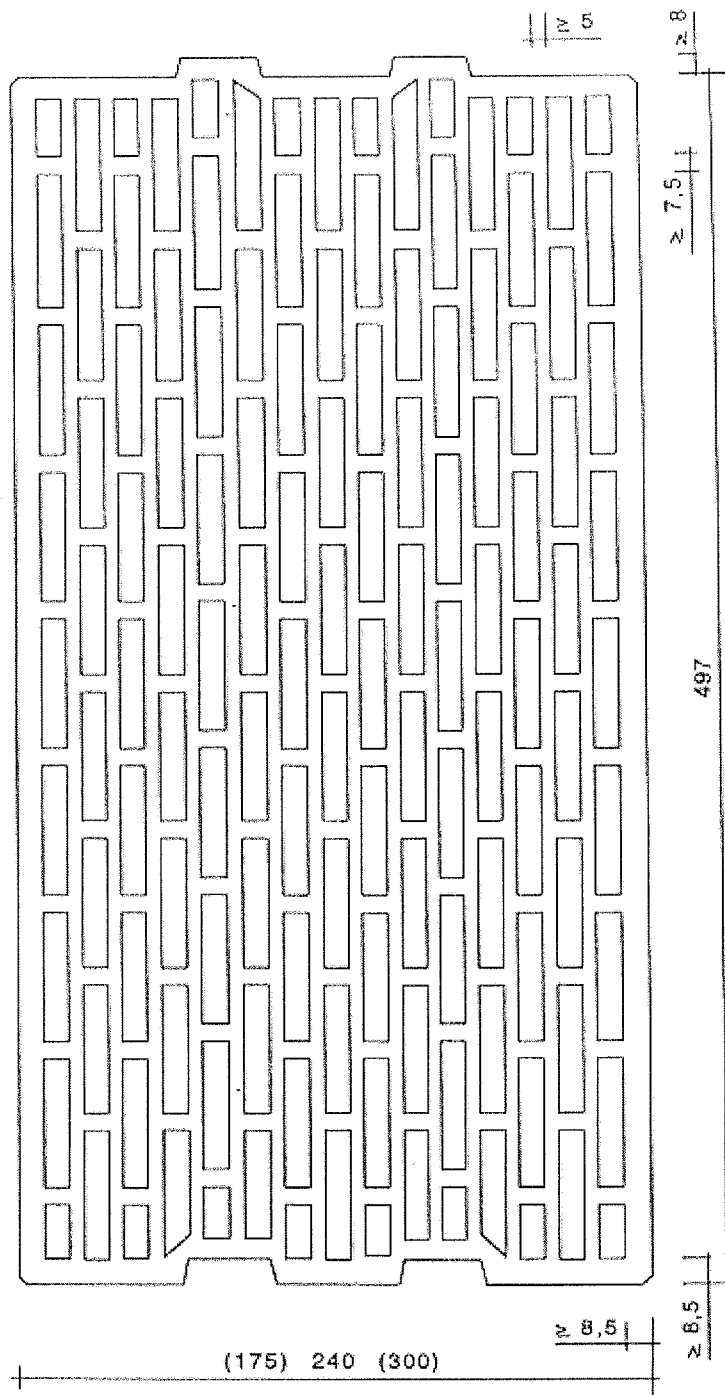

UNIPOR Ziegel Marketing
GmbH
Landsberger Strasse 392
81241 München

UNIPOR
NE-Planziegel

Anlage 4
zur Allgemeinen
bauaufsichtlichen Zulassung
Z-17.1-760
vom 31. März 2006

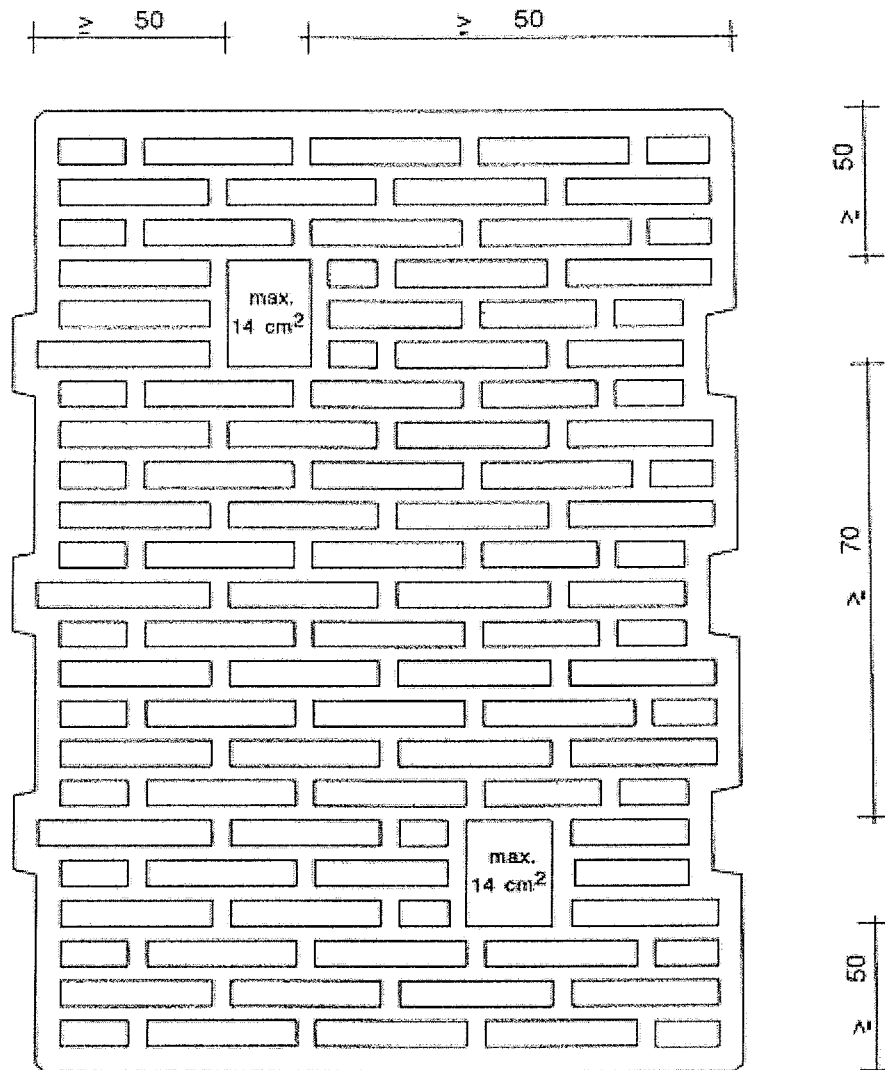

Symboldarstellung Daumenlöcher



UNIPOR Ziegel Marketing GmbH Landsberger Strasse 392 81241 München	UNIPOR NE-Planziegel	Anlage 5 zur Allgemeinen bauaufsichtlichen Zulassung Z-17.1-760 vom 31. März 2006
---	-------------------------	---

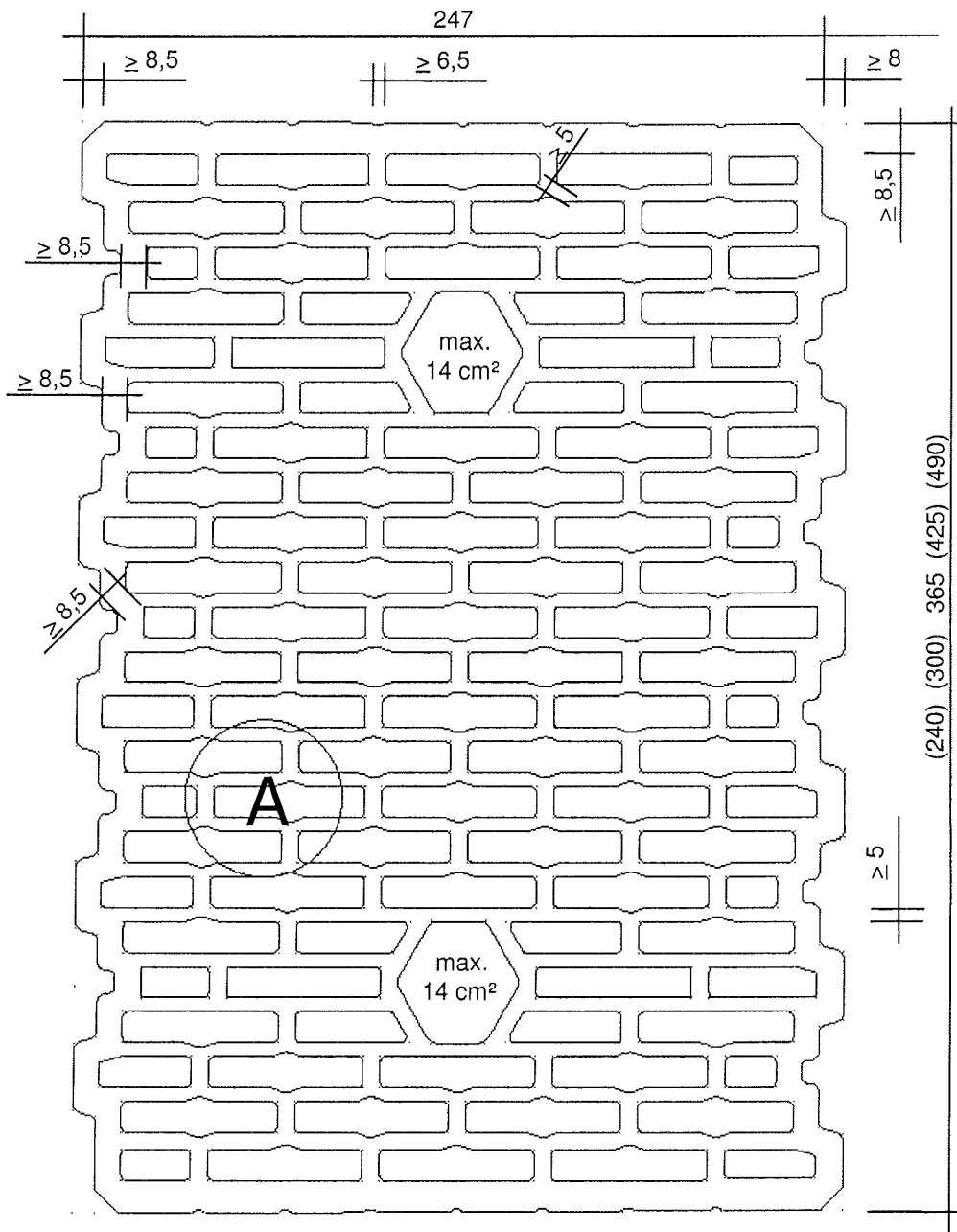

Detail A

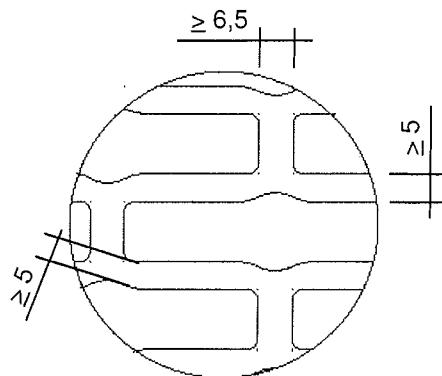

<p>UNIPOR Ziegel Marketing GmbH Landsberger Strasse 392 81241 München</p>	<p>UNIPOR NE-Planziegel</p>	<p>Anlage 6 zur Allgemeinen bauaufsichtlichen Zulassung Z-17.1-760 vom 31. März 2006</p>
---	---------------------------------	--

Symboldarstellungen:

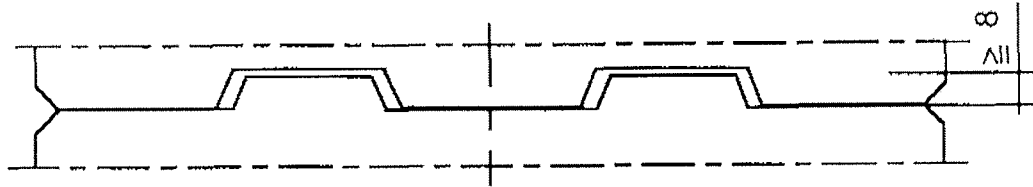

a) symmetrische Verzahnung

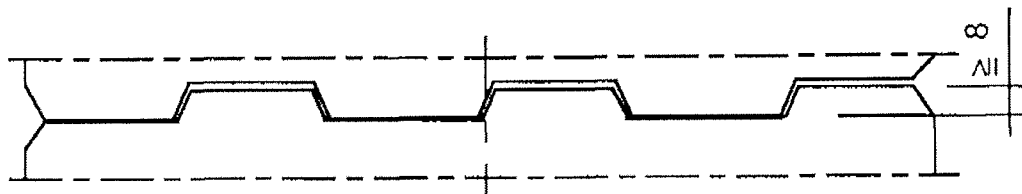

b) asymmetrische Verzahnung



UNIPOR Ziegel Marketing
GmbH
Landsberger Strasse 392
81241 München

UNIPOR
NE-Planziegel

Anlage 7
zur Allgemeinen
bauaufsichtlichen Zulassung
Z-17.1-760
vom 31. März 2006