

<p>UNIPOR Ziegel Marketing GmbH Landsberger Strasse 392 81241 München</p>	<p>UNIPOR NE-D-Planziegel</p>	<p>Anlage 1 zur Allgemeinen bauaufsichtlichen Zulassung Z-17.1-679 vom 31. März 2006</p>
---	-----------------------------------	--

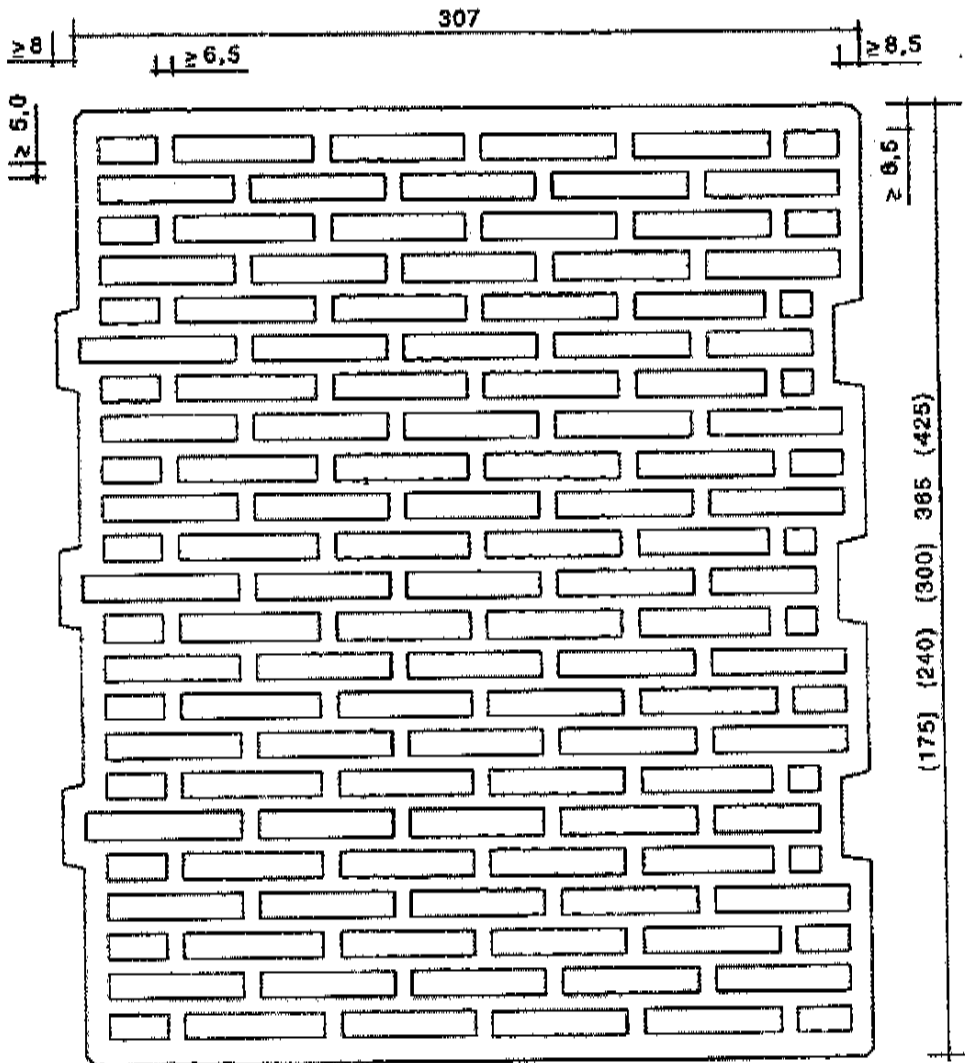

UNIPOR Ziegel Marketing  
GmbH  
Landsberger Strasse 392  
81241 München

UNIPOR  
NE-D-Planziegel

Anlage 2  
zur Allgemeinen  
bauaufsichtlichen Zulassung  
Z-17.1-679  
vom 31. März 2006

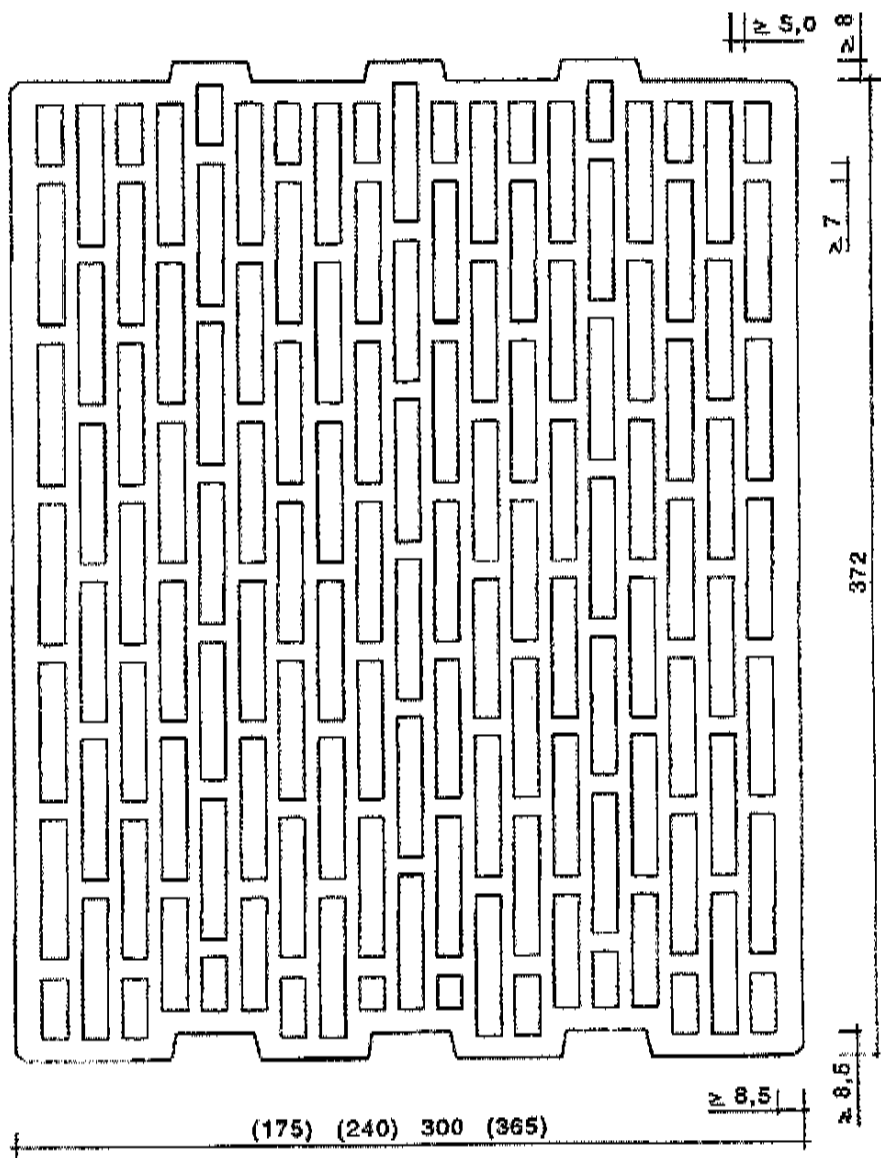

<p>UNIPOR Ziegel Marketing GmbH Landsberger Strasse 392 81241 München</p>	<p>UNIPOR NE-D-Planziegel</p>	<p>Anlage 3 zur Allgemeinen bauaufsichtlichen Zulassung Z-17.1-679 vom 31. März 2006</p>
---	-----------------------------------	--

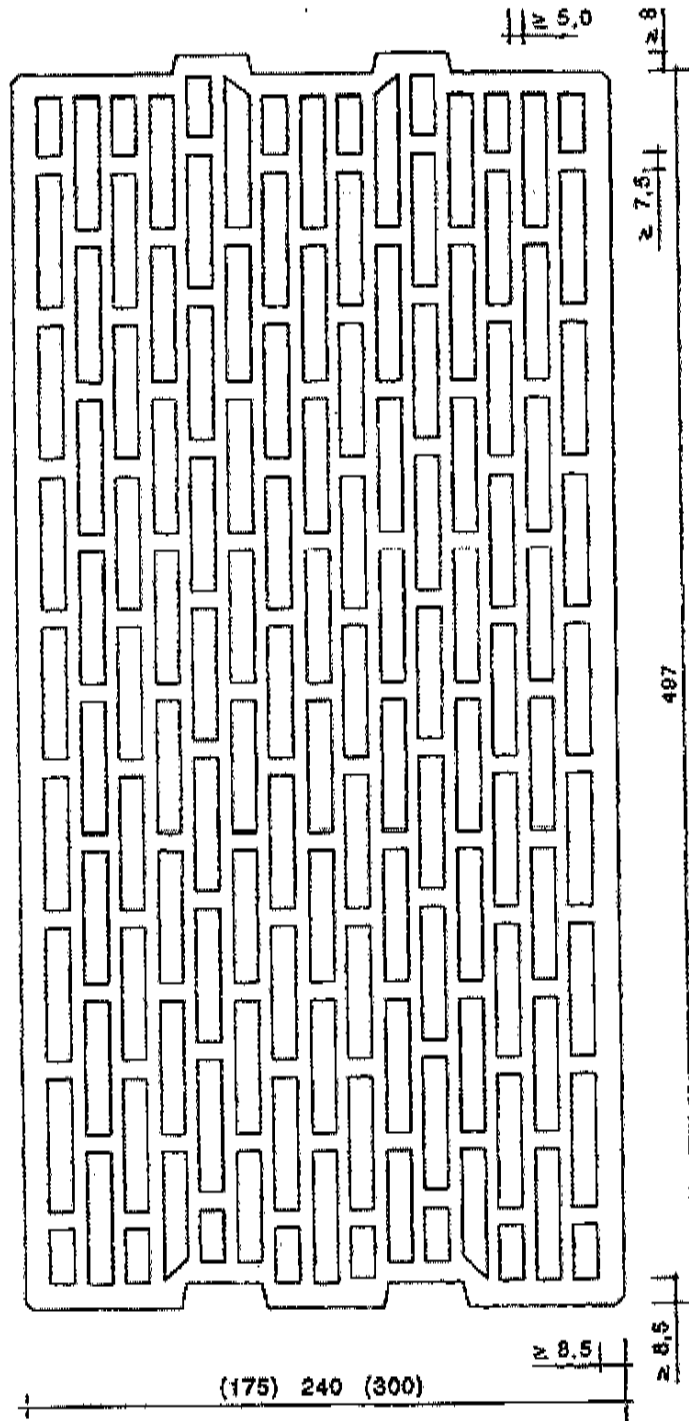

<p>UNIPOR Ziegel Marketing GmbH Landsberger Strasse 392 81241 München</p>	<p>UNIPOR NE-D-Planziegel</p>	<p>Anlage 4 zur Allgemeinen bauaufsichtlichen Zulassung Z-17.1-679 vom 31. März 2006</p>
---	-----------------------------------	--

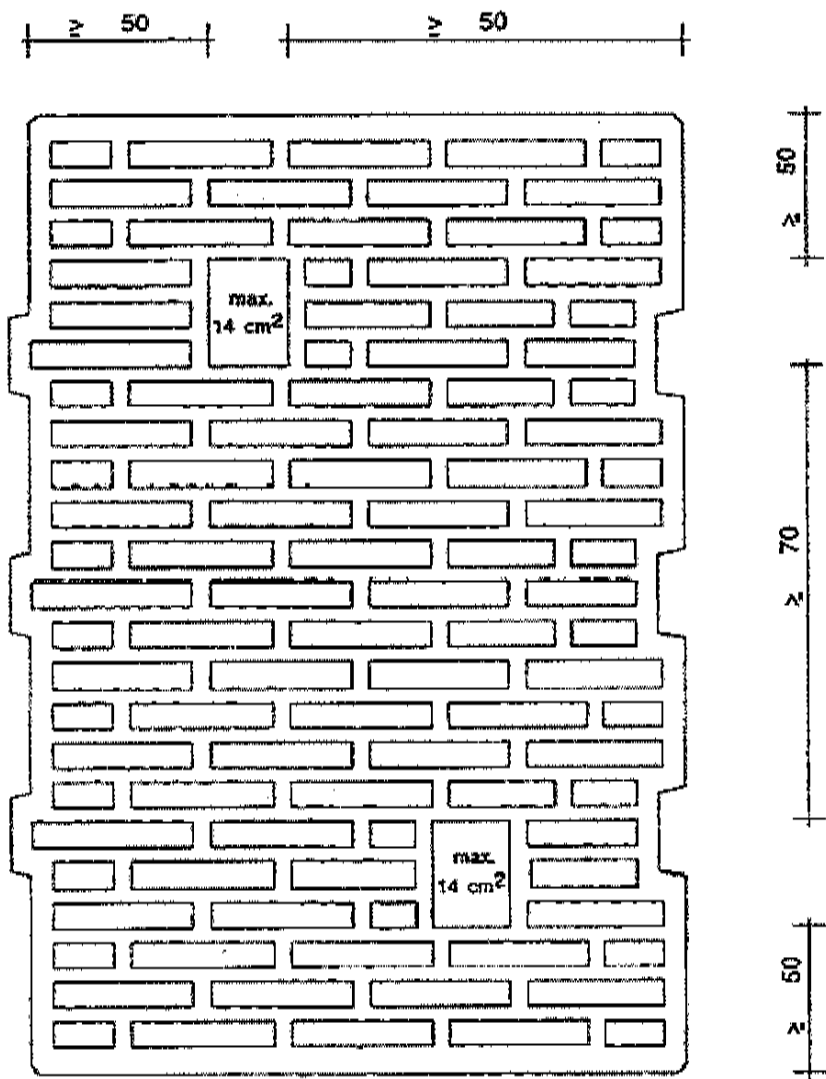

Symboldarstellung Daumenlöcher



UNIPOR Ziegel Marketing  
GmbH  
Landsberger Strasse 392  
81241 München

UNIPOR  
NE-D-Planziegel

Anlage 5  
zur Allgemeinen  
bauaufsichtlichen Zulassung  
Z-17.1-679  
vom 31. März 2006

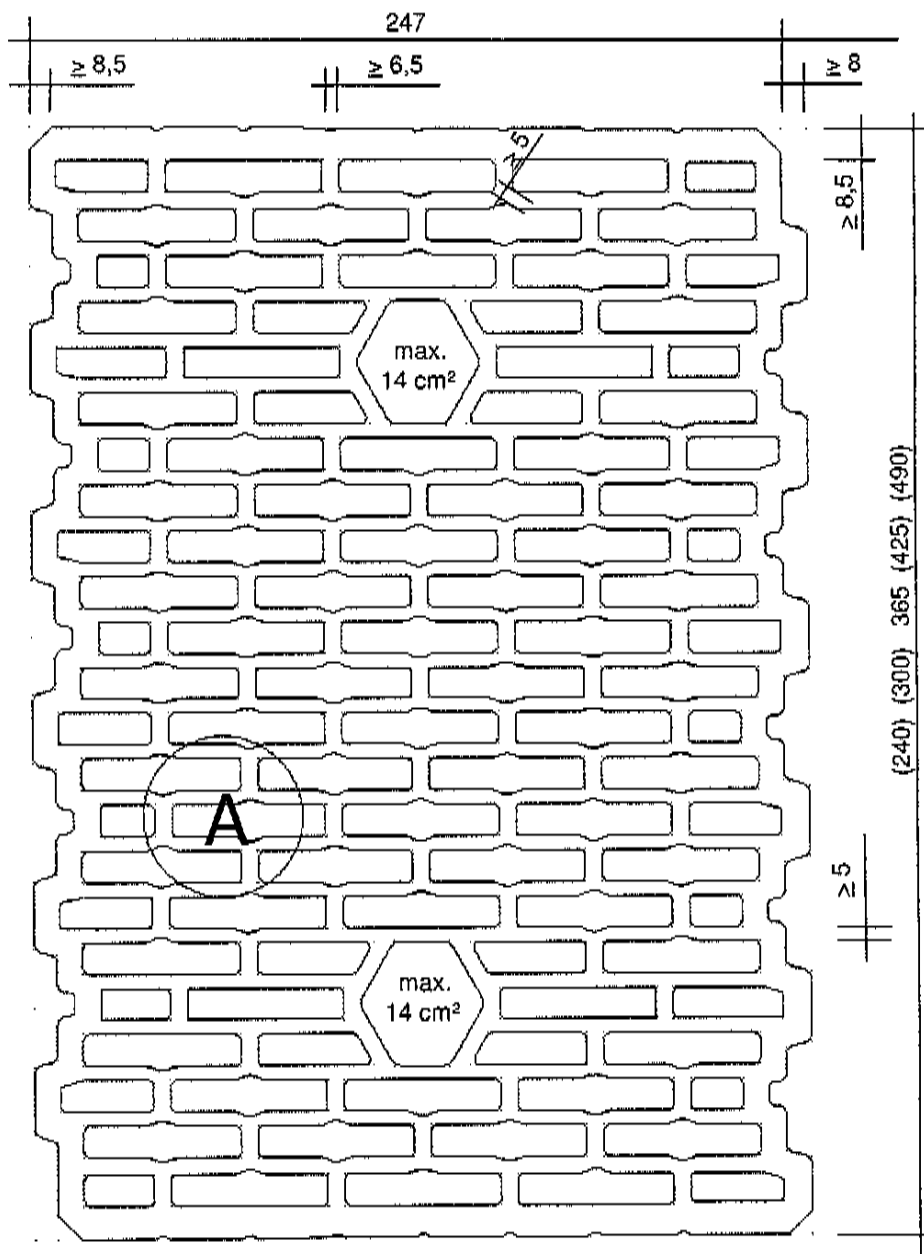

Detail A

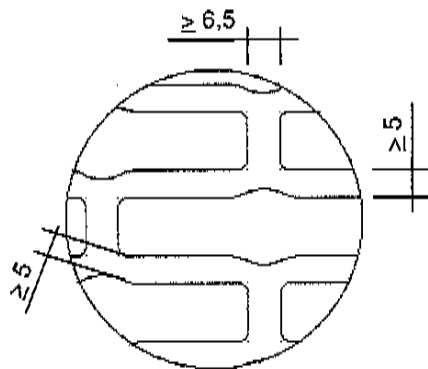

UNIPOR Ziegel Marketing  
GmbH  
Landsberger Strasse 392  
81241 München

UNIPOR  
NE-D-Planziegel

Anlage 6  
zur Allgemeinen  
bauaufsichtlichen Zulassung  
Z-17.1-679  
vom 31. März 2006

Symboldarstellungen:

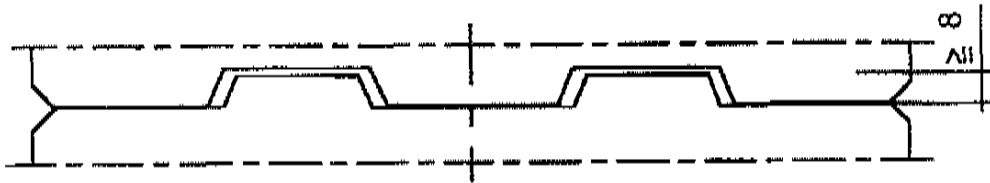

a) symmetrische Verzahnung

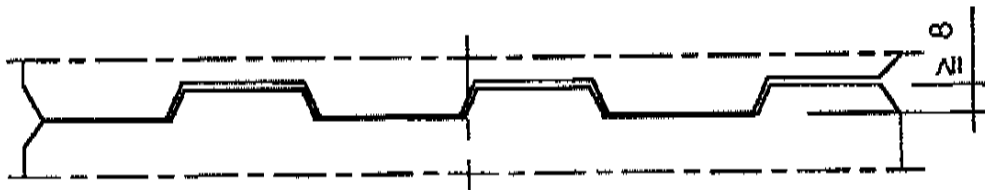

b) asymmetrische Verzahnung



UNIPOR Ziegel Marketing  
GmbH  
Landsberger Strasse 392  
81241 München

UNIPOR  
NE-D-Planziegel

Anlage 7  
zur Allgemeinen  
bauaufsichtlichen Zulassung  
Z-17.1-679  
vom 31. März 2006